

PLEASE CHECK WWW.MOLEX.COM FOR LATEST PART INFORMATION

Part Number: [0545595041](#)
Status: **Active**
Description: 2.54mm (0.100") Pitch QF-50™ Flat Cable Receptacle Housing, 50 Circuits, Central Mating Key

Documents:

[3D Model](#) [Product Specification PS-54559-004 \(PDF\)](#)
[Drawing \(PDF\)](#) [RoHS Certificate of Compliance \(PDF\)](#)

General

Product Family	Ribbon Cable / Wire Trap Connectors
Series	54559
Component Type	Housing
Glow-Wire Compliant	No
Product Name	QF-50™

Physical

Circuits (Loaded)	50
Color - Resin	Black
Durability (mating cycles max)	500
Entry Angle	90° Angle
Lock to Mating Part	Yes
Material - Metal	Phosphor Bronze
Material - Plating Mating	Gold
Material - Plating Termination	Gold
Material - Resin	Polyester
Number of Rows	2
PCB Retention	None
Packaging Type	Tray
Pitch - Mating Interface (in)	0.100 In
Pitch - Mating Interface (mm)	2.54 mm
Plating min: Mating (µin)	12
Plating min: Mating (µm)	0.3
Plating min: Termination (µin)	12
Plating min: Termination (µm)	0.3
Polarized to Mating Part	Yes
Stackable	No
Surface Mount Compatible (SMC)	N/A
Temperature Range - Operating	-40°C to +85°C
Termination Interface: Style	IDT or Pierce
Wire Insulation Diameter	1.14mm (.045") max.
Wire Size AWG	28
Wire/Cable Type	Ribbon Cable

Electrical

Current - Maximum per Contact	1A
Voltage - Maximum	300V

Material Info

Reference - Drawing Numbers

Product Specification	PS-54559-004, RPS-54559-008, RPS-54559-010, RPS-54559-012, RPS-54559-014, RPS-54559-015
Sales Drawing	SD-54559-003

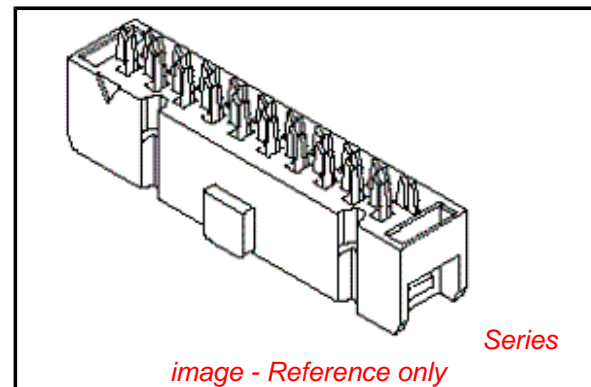

EU RoHS

ELV and RoHS Compliant
REACH SVHC Contains SVHC: No
Halogen-Free Status
Not Reviewed

China RoHS



Need more information on product environmental compliance?

Email productcompliance@molex.com
 For a multiple part number RoHS Certificate of Compliance, [click here](#)

Please visit the [Contact Us](#) section for any non-product compliance questions.

Search Parts in this Series

[54559Series](#)

Mates With

[55401](#) Vertical Header, [55638](#) Right Angle Header

Use With

[54561](#) Strain Relief, [54560](#) Upper Housing

This document was generated on 04/07/2010

PLEASE CHECK WWW.MOLEX.COM FOR LATEST PART INFORMATION

10 9 8 7 6 5 4 3 2 1

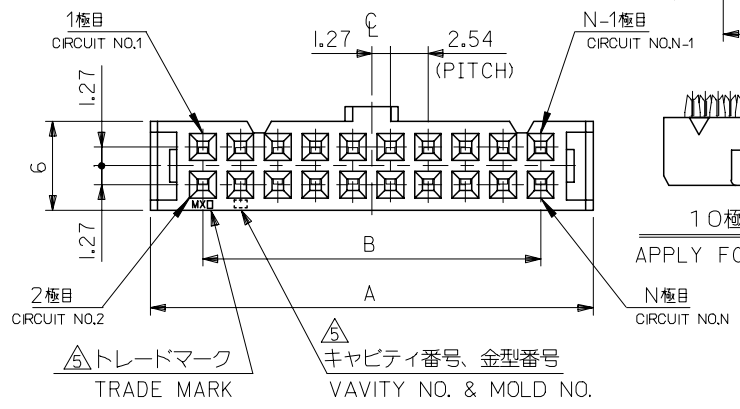
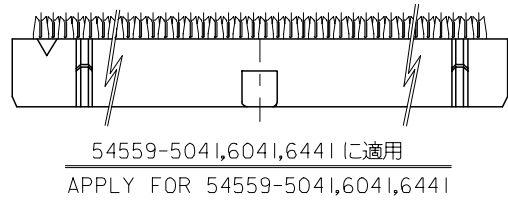
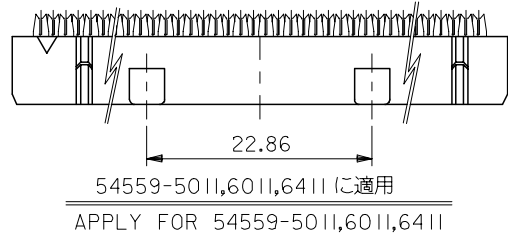
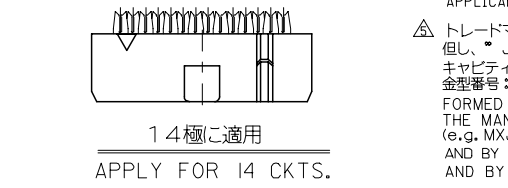
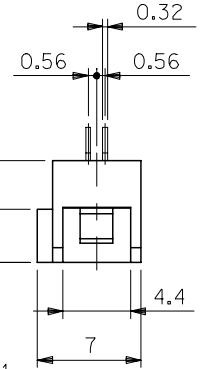
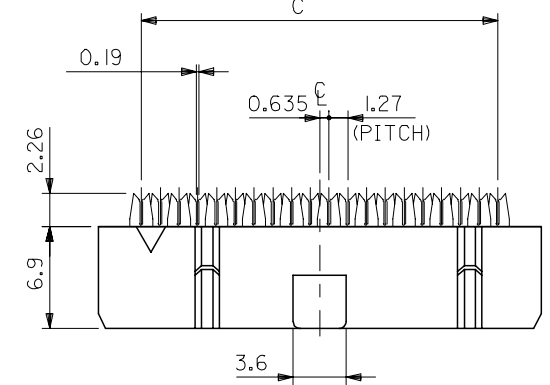
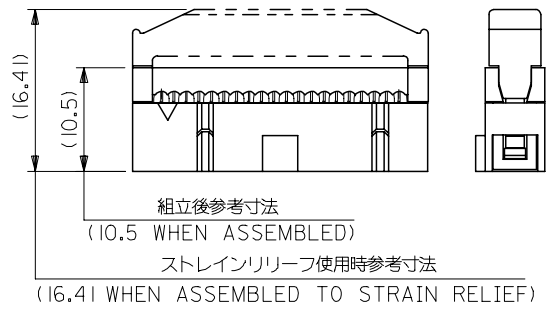
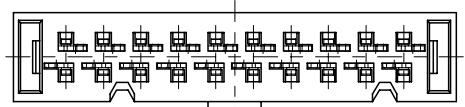

注記 NOTES

- 材料ハウジング : PBT (UL94V-0), 黒色
ターミナル : リン青銅 (ツツケ下地金メッキ)
MATERIAL HOUSING : PBT, UL 94V-0, BLACK
TERMINAL : PHOS. BR. (AU PLATING, NI UNDER-PLATING)
- 適用電線 : 1.27ピッチリボンケーブル 被覆外径 : $\phi 1.14$ MAX.
より線 : AWG#28 (芯線7本構成)
FOR USE WITH AWG#28 STRANDED WIRE
(CONSISTS OF 7 CONDUCTORS)
1.14 DIA. MAX. INSULATION RIBBON CABLE WITH 1.27 CENTERS.
- 嵌合相手 : 55401-***11 は 54559-***11 に適用。
55401-***31 は 54559-***41 に適用。
501577 シリ-ズ は 54559-***11 に適用。
55638-***11 は 54559-***11 に適用。
55638-***31 は 54559-***41 に適用。
MATE WITH : 55401-***11 SUITS 54559-***11
55401-***31 SUITS 54559-***41
501577 SERIES SUITS 54559-***11
55638-***11 SUITS 54559-***11
55638-***31 SUITS 54559-***41.
- 適合アッパーハウジング : 54560-***01
APPLICABLE UPPER HSG : 54560-***01
適合ストレーンリリーフ : 54561-***
APPLICABLE STRAIN RELIEF : 54561-***01

△トレードマーク : MXプラス製造工場を示すアルファベットにて構成
但し、"J" は JAPANを示す。(例 MX J)
キャビティ番号 : 数字で表示。
金型番号 : アルファベットにて構成。
FORMED BY MX AND ALPHABET WHICH MEAN
THE MANUFACTORY, BUT "J" MEANS JAPAN. (TO TRADE MARK)
(e.g. MXJ)
AND BY NUMBERS (TO CAVITY NO.)
AND BY ALPHABET (TO MOLD NO.)

C	B	A	MATERIAL NO.	CKT.
80.01	78.74	85.85	54559-6441	64
			54559-6411	
74.93	73.66	80.77	54559-6041	60
			54559-6011	
62.23	60.96	68.07	54559-5041	50
			54559-5011	
49.53	48.26	55.37	54559-4011	40
41.91	40.64	47.75	54559-3411	34
36.83	35.56	42.67	54559-3011	30
31.75	30.48	37.59	54559-2611	26
24.13	22.86	29.97	54559-2011	20
19.05	17.78	24.89	54559-1611	16
16.51	15.24	22.35	54559-1411	14
11.43	10.16	17.27	54559-1011	10
C	B	A	MATERIAL NO.	CKT.
MODEL NO. 54559-***11				

REVISED EC NO: J2007-2853 DRW: NABEI 2007/04/13 CHK: YMAEDA 2007/04/13 APPR: NUKITA 2007/04/13 DESCRIPTION REV	GENERAL TOLERANCES (UNLESS SPECIFIED)		DIMENSION STYLE MM ONLY		SCALE 3:1	DESIGN UNITS METRIC	THIRD ANGLE PROJECTION
	10 UNDER	±0.2	DRAWN BY S. MATSUZAKI	DATE '99/03/04	TITLE 2.54 FLAT CABLE CONN. REC HOUSING ASSY		
	10 OVER 30 UNDER	±0.25	CHECKED BY S. KUNISHI	DATE '03/08/06			
	30 OVER	±0.3	APPROVED BY T. YAMAGUCHI	DATE '03/08/06	MOLEX MOLEX INCORPORATED		
	ANGULAR	±3 °	MATERIAL NO.	DOCUMENT NO. SD-54559-003			
DRAFT WHERE APPLICABLE MUST REMAIN WITHIN DIMENSIONS		SIZE A3	THIS DRAWING CONTAINS INFORMATION THAT IS PROPRIETARY TO MOLEX INCORPORATED AND SHOULD NOT BE USED WITHOUT WRITTEN PERMISSION				